

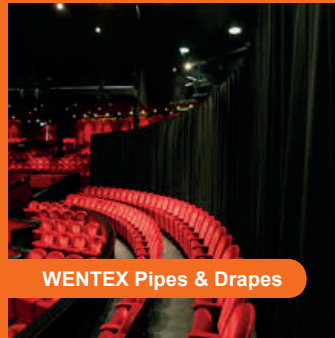

creative textile solutions



WENTEX Pipes & Drapes



WENTEX Eurotrack



WENTEX Textile Products

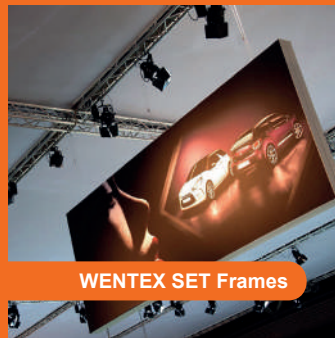

WENTEX SET Frames



# WENTEX Products

## Contents

<b>WENTEX Pipes &amp; Drapes</b> _____	<b>3</b>
WENTEX Pipes & Drapes   Uprights and cross bars _____	8
WENTEX Pipes & Drapes   Accessories _____	9
WENTEX Pipes & Drapes   Curtains _____	11
WENTEX Pipes & Drapes   FOH / Camera surround _____	12
WENTEX Pipes & Drapes   Trolley _____	13
<b>WENTEX Eurotrack</b> _____	<b>14</b>
WENTEX Eurotrack   Parts _____	16
WENTEX Eurotrack   Accessories _____	18
WENTEX Eurotrack   System overview _____	20
<b>WENTEX Textile Products</b> _____	<b>21</b>
WENTEX Textile Products   Stretch shapes _____	24
WENTEX Textile Products   Stage skirts _____	25
WENTEX Textile Products   Spaghetti curtains _____	26
<b>WENTEX SET Frames</b> _____	<b>27</b>
WENTEX SET Frames   A Modules _____	30
WENTEX SET Frames   H Modules _____	31
WENTEX SET Frames   Mounting supplies/accessoires _____	32
WENTEX SET Frames   3D deco panel _____	34







creative textile solutions



**WENTEX Pipes & Drapes**





creative textile solutions



WENTEX Pipes & Drapes | Cover wall



## WENTEX Pipes & Drapes

In the blink of an eye, Cover Walls transform a large hall into an intimate room, or make the front of house more appealing. WENTEX Pipes & Drapes is the multifunctional mobile system to place decorative curtain walls fast and efficiently. With different lengths of curtains and variable uprights and drape supports, nearly every set up imaginable can be built.

### WENTEX Pipes & Drapes are suitable as:

- Decorative covering
- Separation walls
- FOH / Camera surround
- Wardrobes
- Rope & Stanchion





## WENTEX Pipes & Drapes

WENTEX Pipes & Drapes is an easy to use system. This page will explain the basics, followed by complete explanations of all components.

### Telescopic cross bar



Swivelpin

Adjustment knob

### Pipes & Drapes curtain

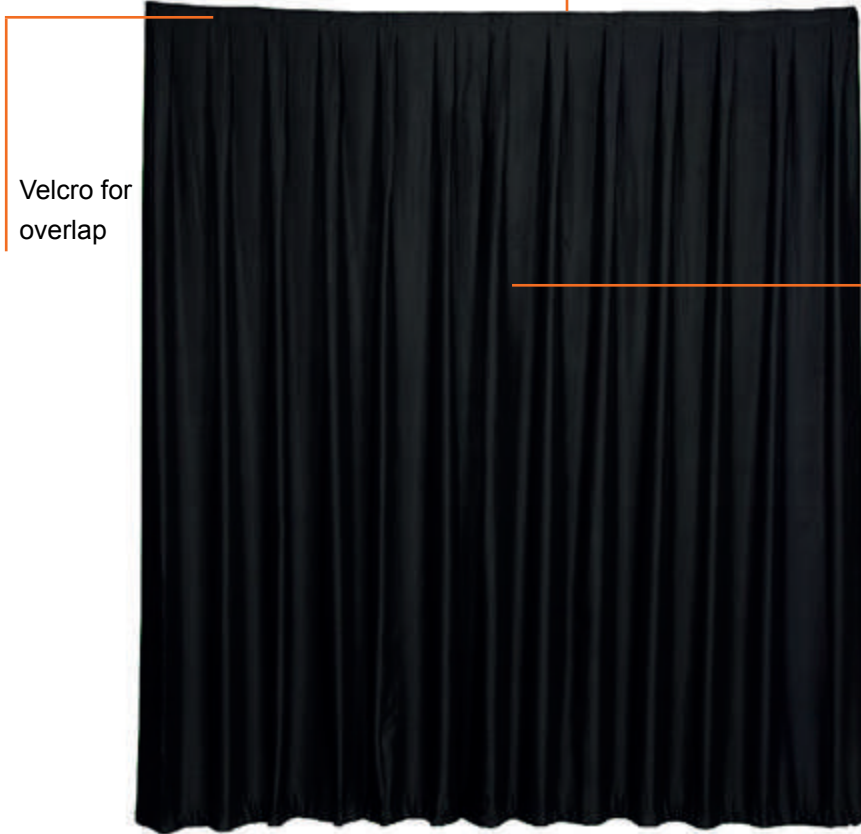

Velcro for overlap

Velcro on backside of the drape support

Pleated finish

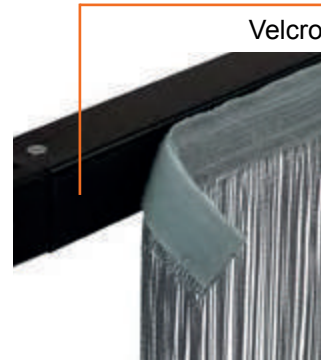

Velcro

### Upright



4-way connector with locking pin

Telescopic adjustable height

### Baseplate



### Baseplate pin



**Baseplate**

Corner assembly

Side assembly

Center assembly

Handle

Rounded corners for safety

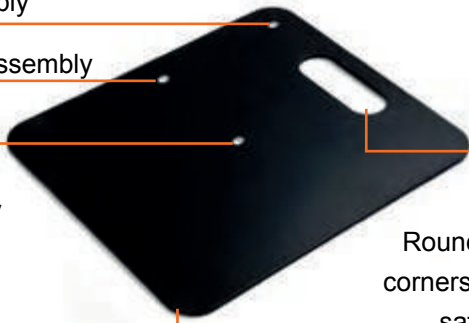

**Baseplates**

Black / White	350 x 300 mm (4.2kg)	450 x 450 mm (8.4kg)	600 x 600 mm (14.67kg)
Black / White	10"x12" (9.2lb)	18"x18" (18.5lb)	24"x24" (32.3lb)

**Baseplate pin**



**Pin heights\***

10 cm / 4"

20 cm / 8"

40 cm / 16"

\*Orange powder coated



**Baseplate with pin**

Baseplate pin

Baseplate

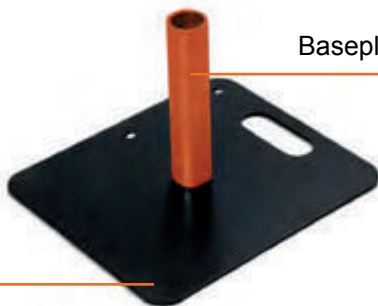

## WENTEX Pipes & Drapes | Uprights

The uprights are made of the material aluminium black & white powder coated.

### Uprights

Fixed upright	120 cm / 4'
2-way upright	120 - 180 cm / 4' - 6'
2-way upright	180 - 300 cm / 6' - 10'
3-way upright	180 - 420 cm / 6' - 14'

### Fixed upright



### 2-way upright



### 3-way upright



### 4-way upright



### Upright

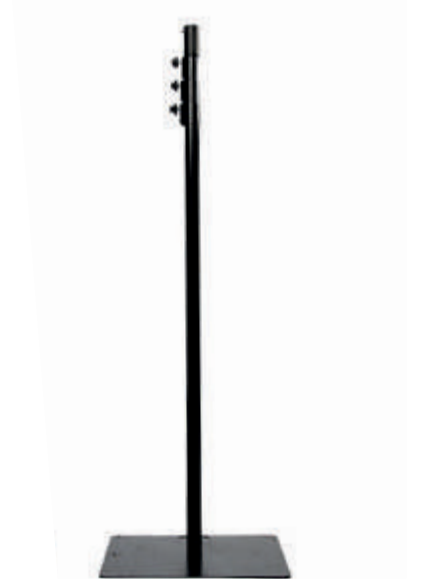

### Knobs



Knobs for adjustment of the drape support and upright

## WENTEX Pipes & Drapes | Cross bar

### Telescopic cross bar

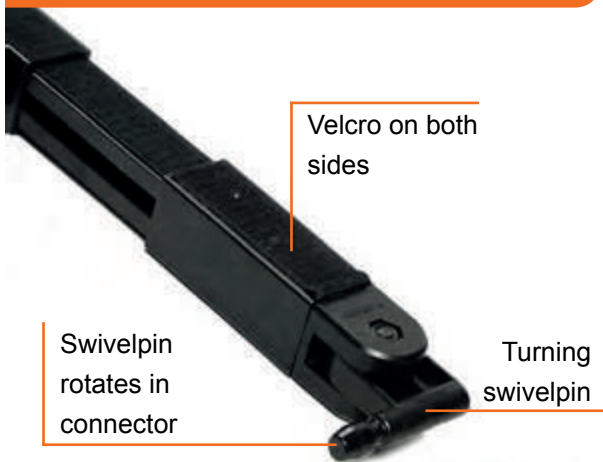

### Cheek set

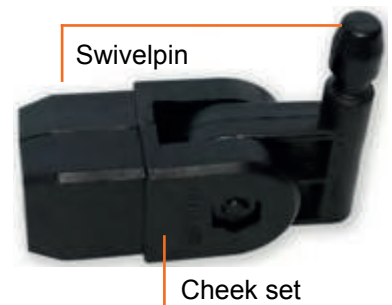

### Drape supports

Metric	Imperial
90 - 120 cm	3' - 4'
120 - 180 cm	4' - 6'
180 - 300 cm	6' - 10'



## WENTEX Pipes & Drapes | Accessories

### 4-way connector

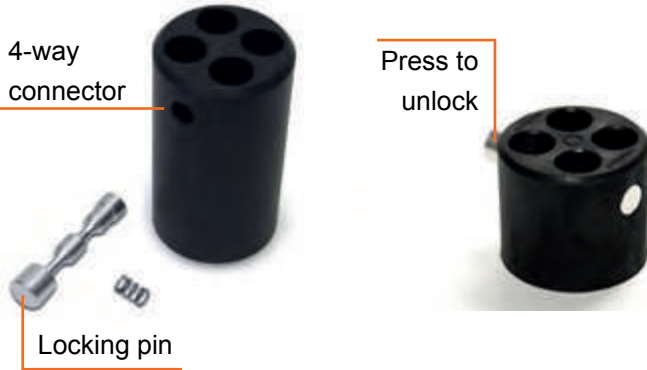

### Half coupler with 4-way connector

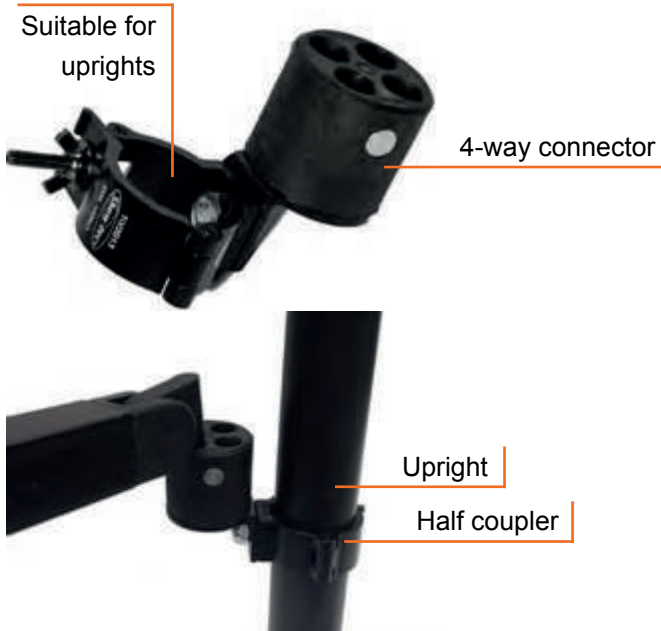

Suitable for uprights up to 50,8 mm / 2". Allows you to attach a drape support at any height on the upright.

### Adapter Kit for Innovative System

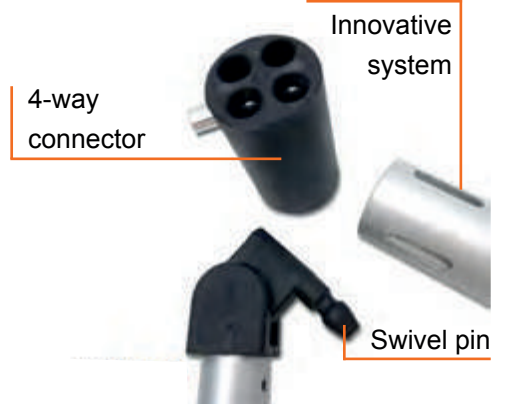

### Flex adapter with 4-way connector



### T-bar

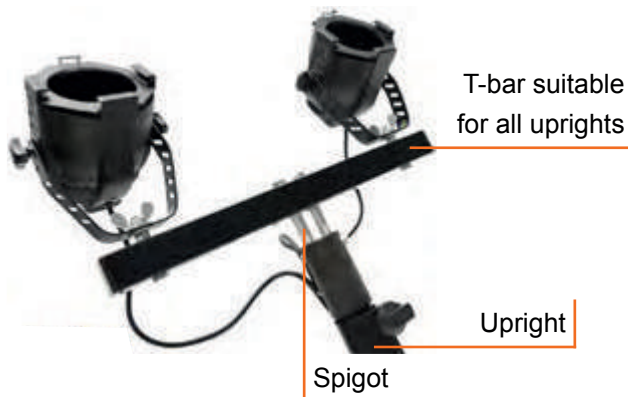

Above accessories are included with the T-bar

## WENTEX Pipes & Drapes | Accessories

### Wagner hook

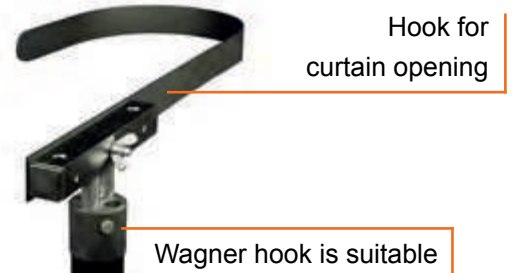
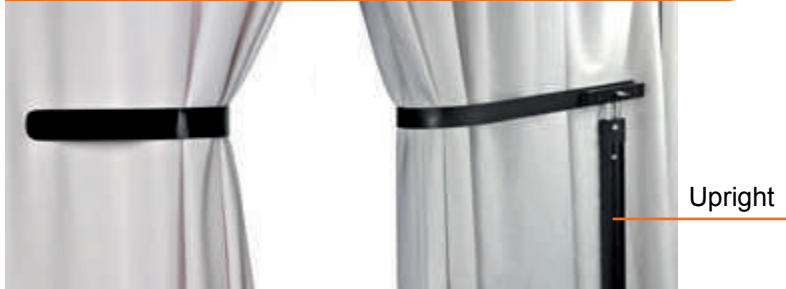

Hook for curtain opening

Upright

Wagner hook is suitable for all uprights.

### Wardrobe rack

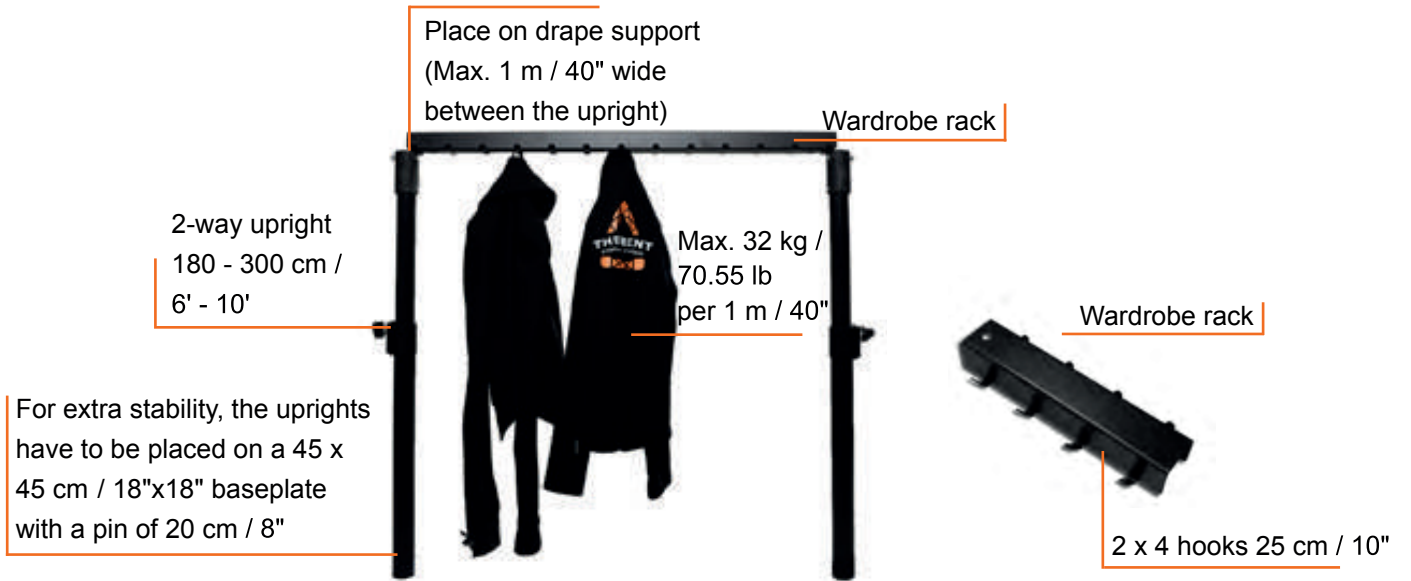

Place on drape support  
(Max. 1 m / 40" wide  
between the upright)

Wardrobe rack

2-way upright  
180 - 300 cm /  
6' - 10'

Max. 32 kg /  
70.55 lb  
per 1 m / 40"

For extra stability, the uprights  
have to be placed on a 45 x  
45 cm / 18"x18" baseplate  
with a pin of 20 cm / 8"

Wardrobe rack

2 x 4 hooks 25 cm / 10"

### Robe & Stanchion



Fixed upright  
(120 cm) / 4'

Baseplate 30 x 35 cm / 10"x12"  
with baseplate pin 10 cm / 4"

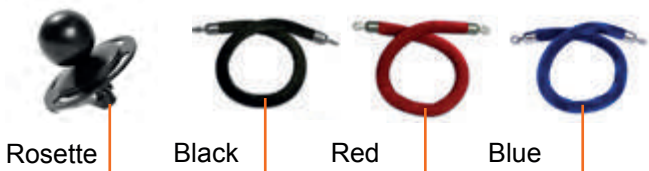

Rosette

Black

Red

Blue

## WENTEX Pipes & Drapes | Curtains

WENTEX Pipes & Drapes Curtains are available in different versions and heights. The curtains are equipped with velcro for an easy and fast set up and are available pleated as well as unpleated. A short strip of velcro on the front makes sure a perfect overlap can be realised.

### Pipes & Drapes Curtains



	Heights metric				Heights imperial			
MCS Black	250 cm	300 cm	400 cm	500 cm	8'	10'	14'	16'
MGS White	250 cm	300 cm	400 cm	500 cm	8'	10'	14'	16'
MGS Black	250 cm	300 cm	400 cm	500 cm	8'	10'	14'	16'
Spaghetti White	250 cm	300 cm	400 cm	500 cm	8'	10'	14'	16'
Spaghetti Grey	250 cm	300 cm	400 cm	500 cm	8'	10'	14'	16'
Spaghetti Black	250 cm	300 cm	400 cm	500 cm	8'	10'	14'	16'
Dimout Light Grey	250 cm	300 cm	400 cm	500 cm	8'	10'	14'	16'
Dimout Burgundy Red	250 cm	300 cm	400 cm	500 cm	8'	10'	14'	16'
Dimout Dark Grey	250 cm	300 cm	400 cm	500 cm	8'	10'	14'	16'
Dimout Yellow	250 cm	300 cm	400 cm	500 cm	8'	10'	14'	16'
Dimout Blue	250 cm	300 cm	400 cm	500 cm	8'	10'	14'	16'
Dimout Brown	250 cm	300 cm	400 cm	500 cm	8'	10'	14'	16'
Dimout White	250 cm	300 cm	400 cm	500 cm	8'	10'	14'	16'
Dimout Black	250 cm	300 cm	400 cm	500 cm	8'	10'	14'	16'

All textile is compliant with the following norms:

EU	USA	UK
DIN4102-B1	NFPA701	BS 5867
NEN-EN 13501-1		



## WENTEX Pipes & Drapes | FOH / Camera surround

The easy-to-build Front of House kit is specially designed for fast and efficient covering of the front of house set. All parts are well-organized in a single flightcase.

Length (flightcase)	Width	Height
120 cm	60 cm	60 cm
4'	2'	2'

With the content of the kit it is possible to make 18 meters / 60' of Pipes & Drapes

FOH kit (flightcase)



FOH kit



Curtains

FOH kit



Uprights and drape supports

FOH kit

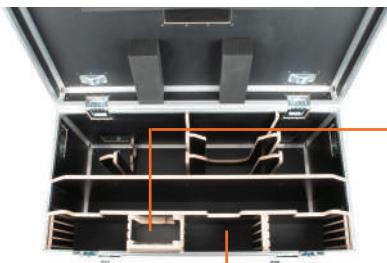

Baseplates

Baseplate connectors

FOH kit



Content of FOH kit



Quantity	Product	Dimensions (metric)	Dimensions (imperial)	Color
12	Baseplates	35 x 30 (4kg)	12" x 10" (8.8lb)	Black
12	Baseplate pins	10 (h) cm	4" (h)	Orange powder coated
12	Telescopic uprights	120 (l) cm x 180 (h) cm	4' (l) x 6' (l)	Black
4	Telescopic cross bar	90 (l) --> 120 (l) cm	3' (l) --> 4' (l)	Black
8	Telescopic cross bar	120 (l) --> 180 (l) cm	4' (l) --> 6' (l)	Black
6	FOH curtains MGS pleated	120 (h) --> 330 (w) cm	4' (h) --> 11' (w)	Black

## WENTEX Pipes & Drapes | Trolley

The easy to transport Pipes & Drapes trolley is specially designed for fast and efficient transport of the Pipes & Drapes system. All parts are well-organized in a single trolley.

Height	Width	Depth
201,5 cm	60 cm	80 cm
79"	24"	32"

With the content of the trolley it is possible to make 36 meters / 100' of Pipes & Drapes



Baseplates



Curtains



Pins

Quantity	Product	Dimensions (metric)	Dimensions (imperial)
10	Baseplates	45 x 45 (8kg)	18" x 18" (18.5lb)
10	Baseplates	60 x 60 (14,67kg)	24" x 24" (32.3lb)
10	Baseplate pins	20 (h) cm	8"(h)
10	Baseplate pins	40 (h) cm	16"(h)
10	Telescopic uprights	180 (l) --> 300 (l) cm	6' (l) --> 10' (l)
10	Telescopic cross bar	180 (l) --> 300 (l) cm	6' (l) --> 10' (l)
10	Curtains	300 (h) --> 330 (w) cm	10' (h) --> 11' (w)

**WENTEX**

creative textile solutions

**WENTEX Eurotrack**





creative textile solutions



WENTEX Eurotrack | Rail System

## WENTEX Eurotrack

WENTEX Eurotrack is a solid track system that can be easily installed for moving textiles for both temporary and permanent use. Using the connection strip, it is a fluently running track system and a variety of runners make it suitable for curtains as well as scenery. It can be used manually, but can also be operated using the optional rope system.

## WENTEX Eurotrack | Parts

### Rail



#### Sizes Rail (length)

200 cm

500 cm

#### Sizes Rail (length)

6'-8"

16'-4"

### Curved rail 90°



#### Curved rail radius

50 cm

100 cm

#### Curved rail radius

20"

40"

### Connection strip



Screws included

### Heavy Duty runner (HD)

HD runner for automatic system for moving textile



Can hold a max. of  
20 kg / 44 lb

### 2-Wheel runner



Can hold a  
max. of  
4 kg / 8.8 lb

Universal mounting bracket



Wall bracket

Rail to wall attachment for three different distances.



100 mm / 3.9"



200 mm / 7.8"

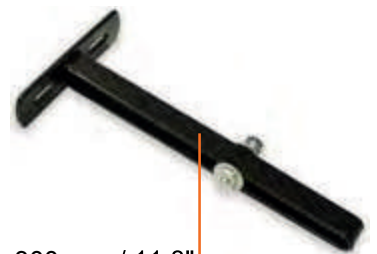

300 mm / 11.8"



Sliding nut

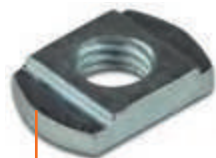

Sliding nut  
per 10 pcs.





## WENTEX Eurotrack | Accessories

### Overlap arm



Overlap arm takes care of overlapping the curtains, so there will be no space between the curtains.



### Ceiling Mount

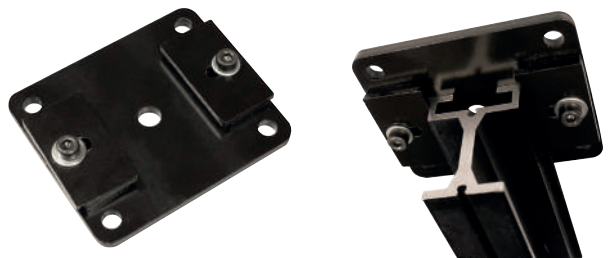

### End stop



Attachment at the end of the rail so the runners stop

### Ceiling Mount - Twist lock



## WENTEX Eurotrack | Accessories

All pulleys for rope system for moving textile.

### Double pulley



Attachment over the rail

### Single pulley



Pulley for attachment above the rail

### Floor pulley



Attachment at the floor

### Pulley



Pulley for attachment weight bag

### Weight bag



5 kg / 11 lb

1 bag needed per 10 m / 32.8' of rail

### Operating rope



Provided on a roll of 100 m / 328'

### Manual switch



## WENTEX Eurotrack | System overview

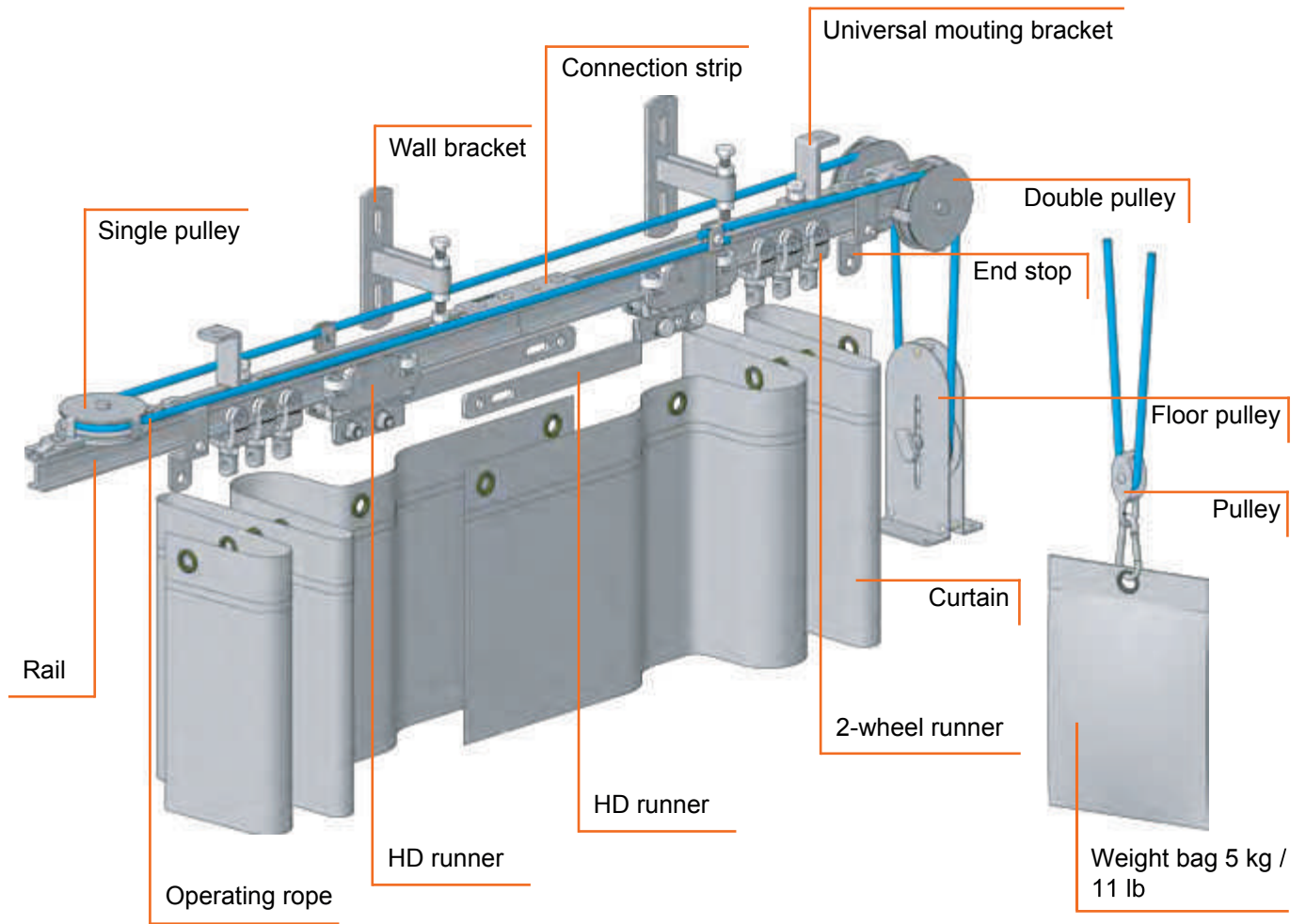



The logo for WENTEX, featuring the brand name in a bold, white, sans-serif font inside a white rounded rectangle with a black border. The background of the entire image is a photograph of a large, modern interior space with a high ceiling of exposed metal trusses and beams. The space is filled with numerous vertical, thin, translucent fabric strips that hang from the ceiling, creating a dense, curtain-like effect. The lighting is dramatic, with strong red and blue hues. In the foreground, a large crowd of people is seated on the floor, looking towards the center of the room. The overall atmosphere is one of a high-tech, artistic event or performance.

**WENTEX**

creative textile solutions

**WENTEX Textile Products**





creative textile solutions

WENTEX Textile Products | Voile





## WENTEX Textile Products

Our Textile products are the finishing touch for your stage, event or meeting. Backdrops, Pipes & Drapes, Stretch shapes, Spaghetti curtains or textiles for decoration are different ways to finish your event. The textiles are available in different colors and sizes. All our textile products are flame retardant following the DIN 4102-B1, NEN-EN 13501-1, NFPA701 and BS 5867 norm.

### WENTEX Textile Products are available as:

- Stretch shapes
- Stage skirts
- Spaghetti curtains





## WENTEX Textile Products | Stretch shapes

Stretch shapes are perfect for specialised decoration and can also be used as a projection screen. Available in three different shapes, square, triangle and diamond. Stretch shapes make great stage backdrops especially with LED lights.

### Attachment loop



Loop for fixation

### Stretch shapes specifications

<b>Fire resistance</b>	DIN 4102-B1
<b>Composition</b>	100% polyester
<b>Extensibility</b>	25% stretch

### Sizes (unstretched) metric (cm)

<b>3-point Triangle</b>	125 x 125	185 x 125	250 x 125	250 x 250	375 x 250	500 x 250	
<b>4-point Diamond</b>	125 x 125	185 x 125	250 x 125	250 x 250	375 x 250	500 x 250	
<b>4-point Square</b>	125 x 125	185 x 125	195 x 195	250 x 125	250 x 250	375 x 250	500 x 250

### Sizes (unstretched) imperial (ft)

<b>3-point Triangle</b>	4.1' x 4.1'	6' x 4.1'	8.2' x 4.1'	8.2' x 8.2'	12.3' x 8.2'	16.4' x 8.2'	
<b>4-point Diamond</b>	4.1' x 4.1'	6' x 4.1'	8.2' x 4.1'	8.2' x 8.2'	12.3' x 8.2'	16.4' x 8.2'	
<b>4-point Square</b>	4.1' x 4.1'	6' x 4.1'	6.4' x 6.4'	8.2' x 4.1'	8.2' x 8.2'	12.3' x 8.2'	16.4' x 8.2'

### Triangle

metric: mm / imperial: ft

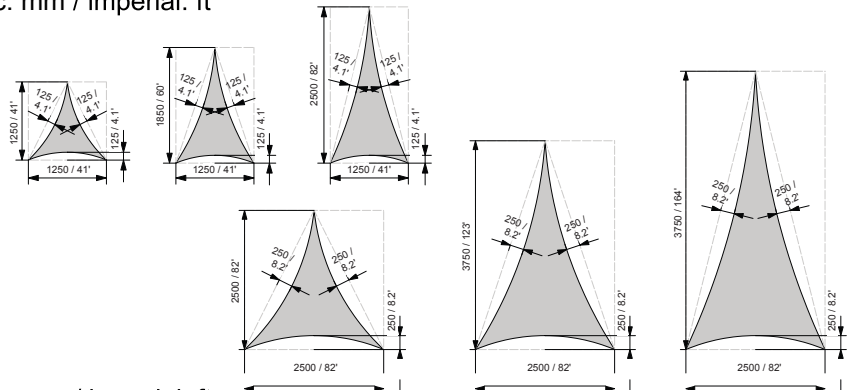

### Diamond

metric: mm / imperial: ft

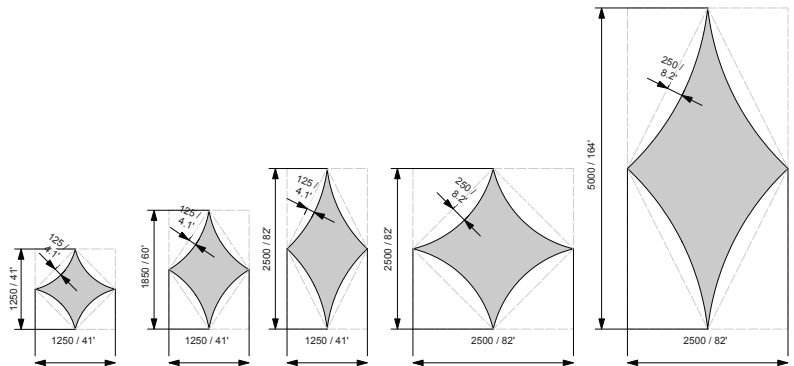

### Square

metric: mm / imperial: ft

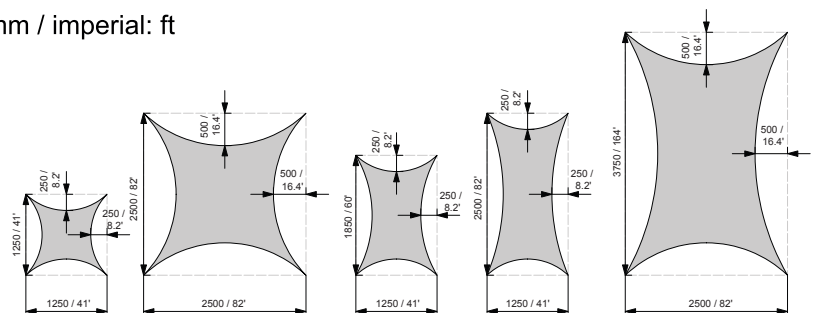

## WENTEX Textile Products | Stage skirts

WENTEX high-quality stage skirts are made from the durable and flame-retardant MCS fabric. Perfect for any stage production or event, our skirts come in two versions: unpleated and pleated, so you can choose the style that best suits your needs. MCS fabric is a permanent flame retardant material, which means that it will remain fire-resistant for the lifetime of the skirt. This added safety feature gives you peace of mind, knowing that your production is in good hands. The unpleated version of our skirt is sleek and simple, providing a clean and professional look for your stage. The pleated version, on the other hand, adds a touch of elegance and sophistication, making it ideal for more formal productions.



Sizes		Metric
MCS	Pleated	40(h) x 620(w) cm
MCS	Pleated	60(h) x 620(w) cm
MCS	Pleated	80(h) x 620(w) cm
MCS	Pleated	100(h) x 620(w) cm
MCS	Unpleated	40(h) x 620(w) cm
MCS	Unpleated	60(h) x 620(w) cm
MCS	Unpleated	80(h) x 620(w) cm
MCS	Unpleated	100(h) x 620(w) cm

Sizes		Imperial
MCS	Pleated	16"(h) x 25'(l)
MCS	Pleated	24"(h) x 25'(l)
MCS	Pleated	31"(h) x 25'(l)
MCS	Pleated	40"(h) x 25'(l)
MCS	Unpleated	16"(h) x 25'(l)
MCS	Unpleated	24"(h) x 25'(l)
MCS	Unpleated	31"(h) x 25'(l)
MCS	Unpleated	40"(h) x 25'(l)

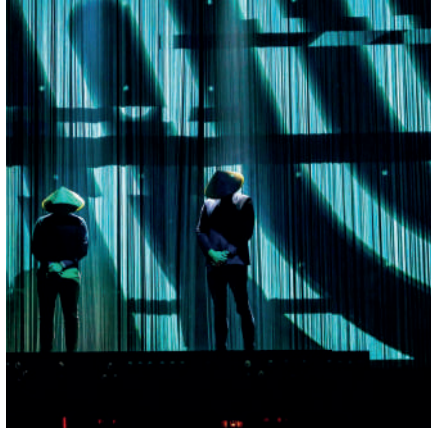

## WENTEX Textile Products | Spaghetti curtains

### Spaghetti curtain



Spaghetti Black



Spaghetti Grey



Spaghetti White

### Rapido - Curtain Clamp



Spaghetti curtains are beautiful curtains that create a special effect, bringing a touch of glamour to your event.

Composition: 100% polyester  
 Flame retardant: DIN 4102-B1  
 NEN-EN 13501-1  
 NFPA701  
 BS 5867

Washability: Not washable

#### Sizes (metric)

Width	3 m	3 m	3 m	3 m
Height	3 m	4 m	5 m	6 m

#### Sizes (imperial)

Width	9.8'	9.8'	9.8'	9.8'
Height	9.8'	13.1'	16.4'	19.7'







**WENTEX**

creative textile solutions

**WENTEX SET Frames**



**WENTEX**

creative textile solutions



WENTEX SET Frames





## WENTEX SET Frames

The Wentex SET Frame Module is a lightweight modular aluminum system for quickly and easily creating SEG applications like branding, exhibition stands or projection screens. It is a very modular system for a height of up to 6 meters / 20'. You can make the frame as angular and wide as you want. In addition, front projections are possible, as well as creating an intermediate compartment for seamless LED screen installations. This is an ideal framing solution for silicone-edge graphics at conferences, exhibitions, trade shows, seminars, and TV studios. SET Frame modules are available in different sizes, allowing you to create different combinations and setups with sizes in an increment of 25 cm / 1'. They are equipped with a quickly built-in stacking system. Clamps ensure that frames can be securely and seamlessly attached to each other and Wentex Base Plates can be used to create a strong and stable base.

### WENTEX

- A modules
- H modules
- Mounting supplies/accessoires
- 3D deco panel

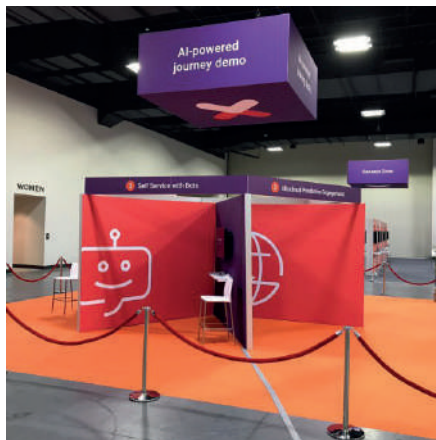



## WENTEX A Modules

The A Modules build the top and bottom ends of your frame. They come with inner bracket connecting components for connecting corners and straight parts in one frame together. They slide into the profile that is extruded in the inside of the studs that make up the frame, much like keder strips. The included butterfly screws keep the straight and corner strips in place.

For a sturdy connection between multiple horizontally placed module frames, dedicated Module Clamps provide a fast and reliable link. Module Clamps are also available with an attached half coupler, which can be used to easily connect the frame to round tubing like Wentex Pipe & Drape Uprights or truss. For right-angled module connections there is the Module Clamp for Brace. This works like a regular Module Clamp, but an additional butterfly is included to fix the right-angled module in place.



Height (cm)	Width (cm)	Height (ft)	Width (ft)
25	25	1	1
25	50	1	2
25	75	1	3
25	100	1	4
50	25	2	1
50	50	2	2
50	75	2	3
50	100	2	4
75	25	3	1
75	50	3	2
75	75	3	3
75	100	3	4
100	25	4	1
100	50	4	2
100	75	4	3
100	100	4	4
38*	100		
69*	100		
81*	100		
94*	100		

\* for 16:9 projection screens



## WENTEX H Modules

The H Modules are used to extend an A Module up to the height that is needed (up to 6 metres maximum). They too come with inner bracket connecting components for connecting corners and straight parts in one frame together. The same Module Clamps can be used to connect multiple H Modules together horizontally, at a right angle, or to a round Pipe & Drape Upright or truss.

Please note that for connecting an H Module to an A Module you will need two additional pieces of the Wentex Connection Strip for SET Frame.



Height (cm)	Width (cm)	Height (ft)	Width (ft)
100	25	4	1
100	50	4	2
100	75	4	3
100	100	4	4



## WENTEX SET Frames | Mounting supplies/accessoires

Module Clamp



Module Clamp halfcoupler

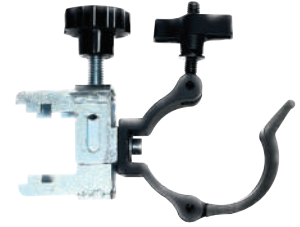

4-way coupling profile with SEG Channel



Module Cross Spacer



### Lengths

25 cm / 10"

50 cm / 20"

100 cm / 40"

200 cm / 6.6'

250 cm / 8'

### Lengths

50 cm / 20"

100 cm / 40"

Module Swivel Clamp

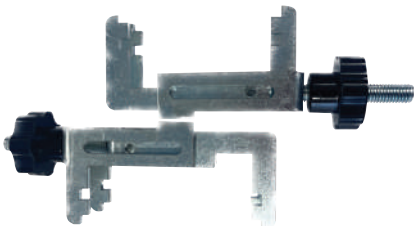

Module Support Swivel Clamp





## WENTEX SET Frames | Mounting supplies/accessoires

Keder corner



Spacer

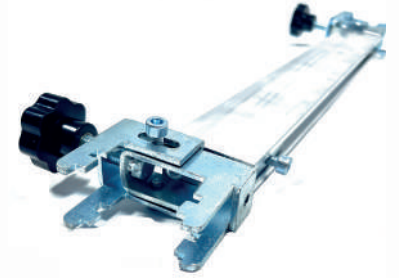

Keder mounting strip



Lengths

300 x 15 mm / 12" x 0.6"

Outrigger



Lengths

20 cm / 8"

30 cm / 12"





creative textile solutions

WENTEX SET Frame | 3D deco panel



## WENTEX 3D deco panel

3D deco panels enables you to create unique scenic backdrops, screen surrounds, entryways and freestanding walls, towers or columns. Freestanding walls can go up to 5 meters / 16'. The 3D deco panels can also easily hang from a truss grid. Easy assembly enables the product to be installed quickly without the need of any tools.

### Dimension

1 x 1 m / 4' x 4'

### 3D decopanel Bridge



### 3D decopanel Double Wave



### 3D decopanel Diagonal



### 3D decopanel stretch panel

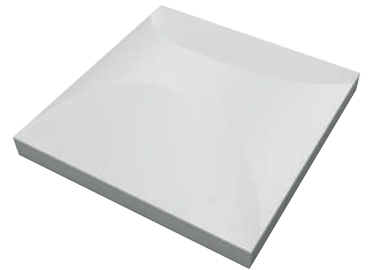

### 3D decopanel Venturi closed



### 3D decopanel Venturi open



### 3D decopanel Venturi slim



### 3D decopanel Wave

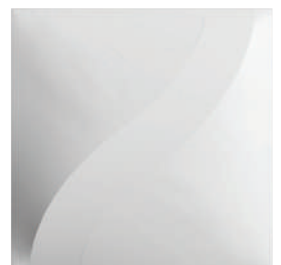



WENTEX equips events, fairs and theaters with innovative textile solutions.

All WENTEX products focus on the professional circuit, are constantly innovated and are fully compatible with each other. A very convenient solution for you. Visit our website and check out our wonderful products! - [www.wentex.eu](http://www.wentex.eu)



creative textile solutions

[www.wentex.eu](http://www.wentex.eu)